

To all our customers

---

## **Regarding the change of names mentioned in the document, such as Mitsubishi Electric and Mitsubishi XX, to Renesas Technology Corp.**

---

The semiconductor operations of Hitachi and Mitsubishi Electric were transferred to Renesas Technology Corporation on April 1st 2003. These operations include microcomputer, logic, analog and discrete devices, and memory chips other than DRAMs (flash memory, SRAMs etc.) Accordingly, although Mitsubishi Electric, Mitsubishi Electric Corporation, Mitsubishi Semiconductors, and other Mitsubishi brand names are mentioned in the document, these names have in fact all been changed to Renesas Technology Corp. Thank you for your understanding. Except for our corporate trademark, logo and corporate statement, no changes whatsoever have been made to the contents of the document, and these changes do not constitute any alteration to the contents of the document itself.

Note : Mitsubishi Electric will continue the business operations of high frequency & optical devices and power devices.

Renesas Technology Corp.  
Customer Support Dept.  
April 1, 2003

# FS16UMA-5A

HIGH-SPEED SWITCHING USE

## FS16UMA-5A

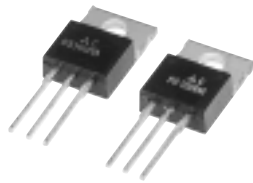

- 10V DRIVE
- $V_{DSS}$  ..... 250V
- $r_{DS(ON)}(MAX)$  .....  $0.25\Omega$
- $I_D$  ..... 16A

## OUTLINE DRAWING

Dimensions in mm

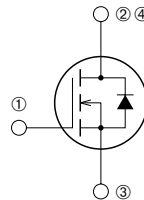
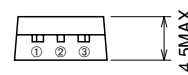
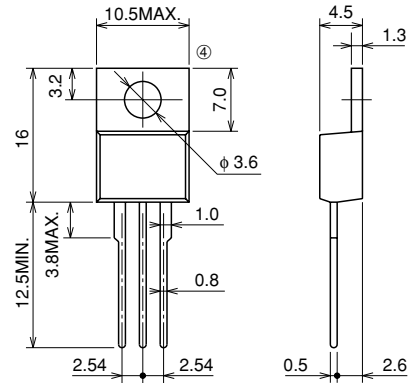

- ① GATE
- ② DRAIN
- ③ SOURCE
- ④ DRAIN

TO-220

## APPLICATION

CRT Display monitor, SMPS, etc.

## MAXIMUM RATINGS (Tc = 25°C)

Symbol	Parameter	Conditions	Ratings	Unit
$V_{DSS}$	Drain-source voltage	$V_{GS} = 0V$	250	V
$V_{GSS}$	Gate-source voltage	$V_{DS} = 0V$	$\pm 20$	V
$I_D$	Drain current		16	A
$I_{DM}$	Drain current (Pulsed)		48	A
$I_{DA}$	Avalanche current (Pulsed)	$L = 200\mu H$	16	A
$P_D$	Maximum power dissipation		110	W
$T_{ch}$	Channel temperature		-55 ~ +150	°C
$T_{stg}$	Storage temperature		-55 ~ +150	°C
—	Weight	Typical value	2.0	g

# FS16UMA-5A

HIGH-SPEED SWITCHING USE

## ELECTRICAL CHARACTERISTICS (Tch = 25°C)

Symbol	Parameter	Test conditions	Limits			Unit
			Min.	Typ.	Max.	
V(BR)DSS	Drain-source breakdown voltage	Id = 1mA, VGS = 0V	250	—	—	V
IGSS	Gate-source leakage current	VGS = ±20V, VDS = 0V	—	—	±0.1	μA
IDSS	Drain-source leakage current	VDS = 250V, VGS = 0V	—	—	1	mA
VGS(th)	Gate-source threshold voltage	Id = 1mA, VDS = 10V	2.0	3.0	4.0	V
rDS(ON)	Drain-source on-state resistance	Id = 8A, VGS = 10V	—	0.19	0.25	Ω
VDS(ON)	Drain-source on-state voltage	Id = 8A, VGS = 10V	—	1.52	2.00	V
yfs	Forward transfer admittance	Id = 8A, VDS = 10V	—	16.0	—	S
Ciss	Input capacitance	VDS = 25V, VGS = 0V, f = 1MHz	—	1850	—	pF
Coss	Output capacitance		—	180	—	pF
Crss	Reverse transfer capacitance		—	50	—	pF
td(on)	Turn-on delay time	VDD = 150V, Id = 8A, VGS = 10V, RGEN = RGS = 50Ω	—	30	—	ns
tr	Rise time		—	50	—	ns
td(off)	Turn-off delay time		—	320	—	ns
tf	Fall time		—	70	—	ns
VSD	Source-drain voltage	IS = 8A, VGS = 0V	—	1.5	2.0	V
Rth(ch-c)	Thermal resistance	Channel to case	—	—	1.14	°C/W

## PERFORMANCE CURVES

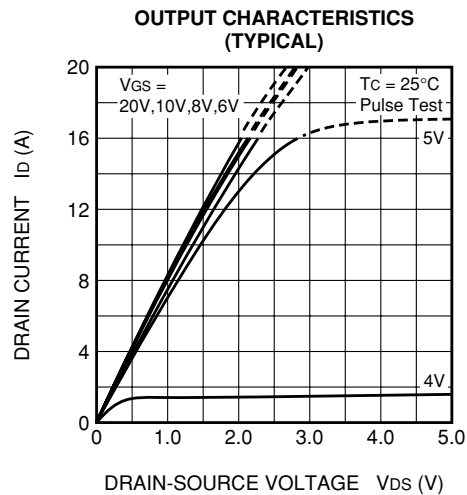
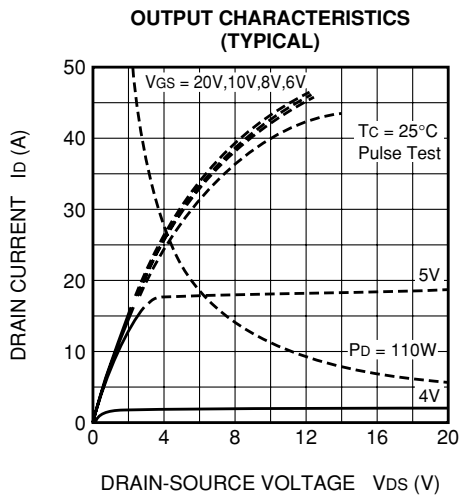
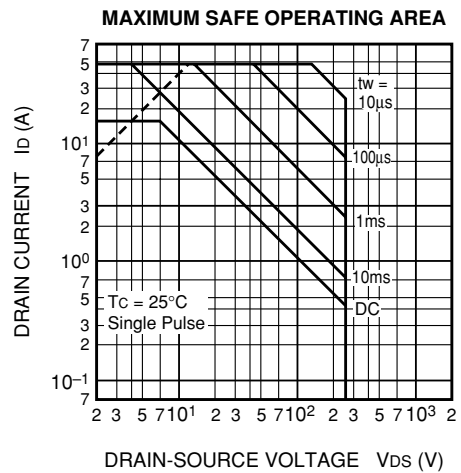
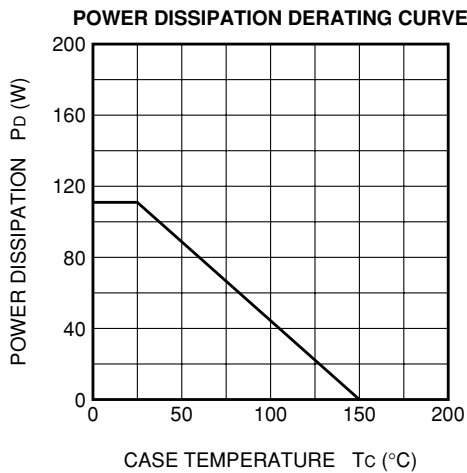

# FS16UMA-5A

HIGH-SPEED SWITCHING USE

**ON-STATE VOLTAGE VS. GATE-SOURCE VOLTAGE (TYPICAL)**

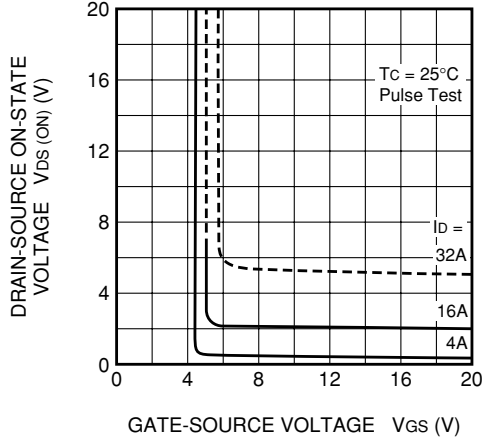

**ON-STATE RESISTANCE VS. DRAIN CURRENT (TYPICAL)**

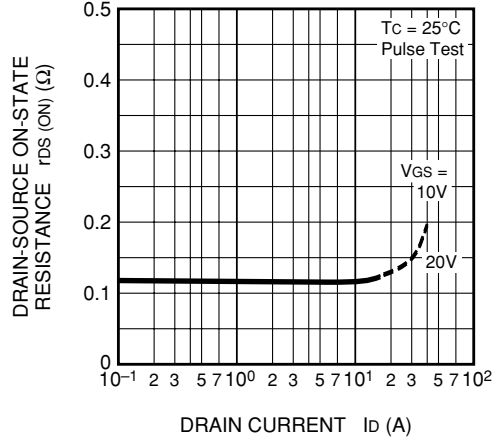

**TRANSFER CHARACTERISTICS (TYPICAL)**

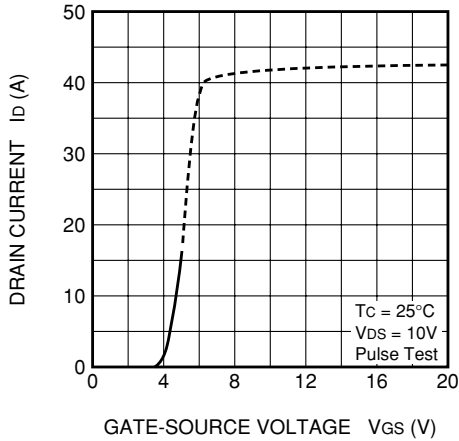

**FORWARD TRANSFER ADMITTANCE VS. DRAIN CURRENT (TYPICAL)**

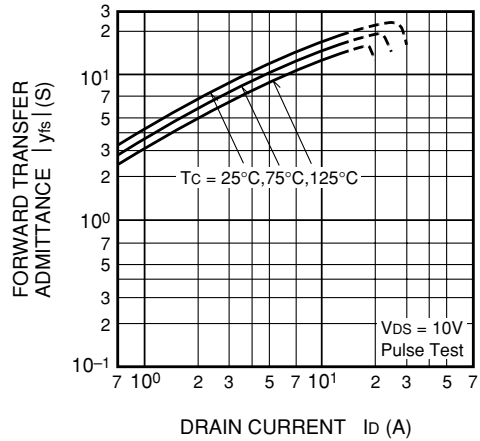

**CAPACITANCE VS. DRAIN-SOURCE VOLTAGE (TYPICAL)**

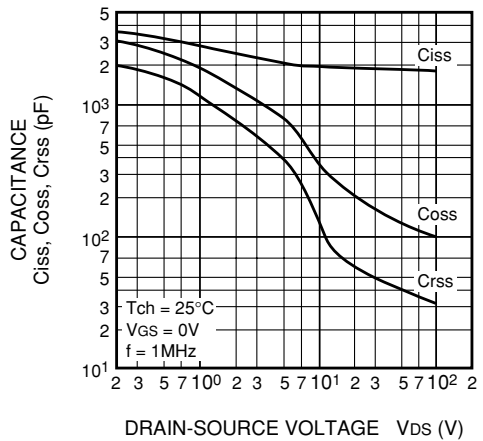

**SWITCHING CHARACTERISTICS (TYPICAL)**

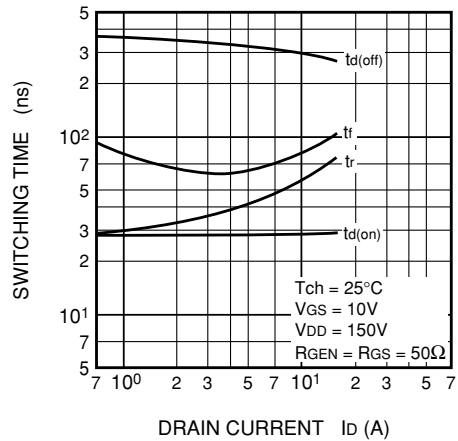

# FS16UMA-5A

HIGH-SPEED SWITCHING USE

**GATE-SOURCE VOLTAGE VS. GATE CHARGE (TYPICAL)**

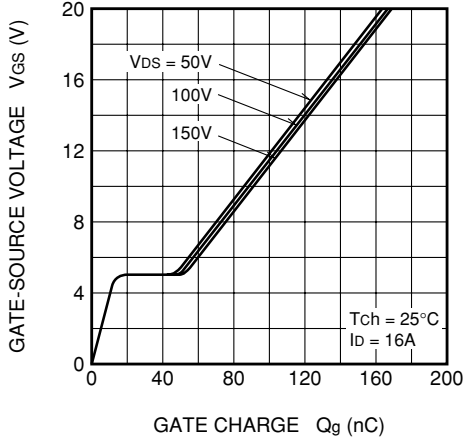

**SOURCE-DRAIN DIODE FORWARD CHARACTERISTICS (TYPICAL)**

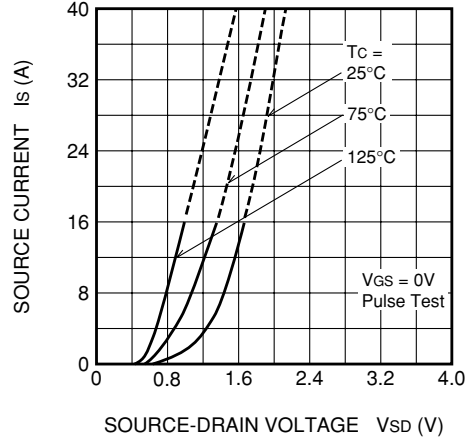

**ON-STATE RESISTANCE VS. CHANNEL TEMPERATURE (TYPICAL)**

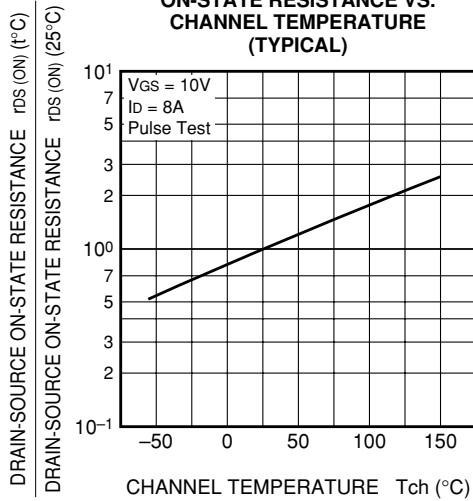

**THRESHOLD VOLTAGE VS. CHANNEL TEMPERATURE (TYPICAL)**

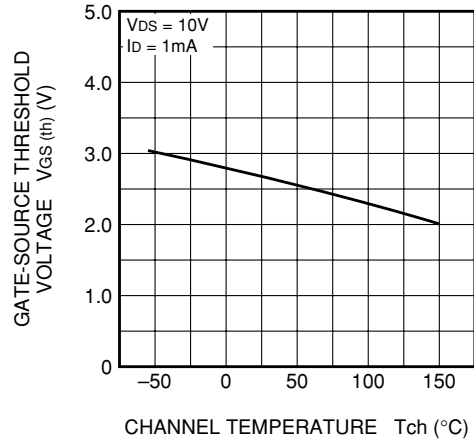

**BREAKDOWN VOLTAGE VS. CHANNEL TEMPERATURE (TYPICAL)**

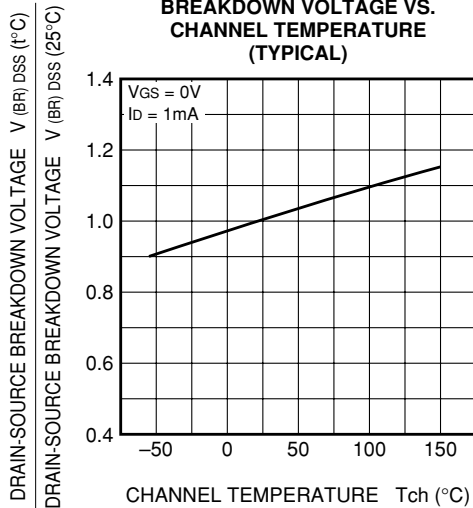

**TRANSIENT THERMAL IMPEDANCE CHARACTERISTICS**

